



EXPOSED,
DEMOUNTABLE

Resistance to fire REI 30.
Passed all tests
successfully

OWAlifetime collection

OWA

System S 15b OWAline | exposed, demountable

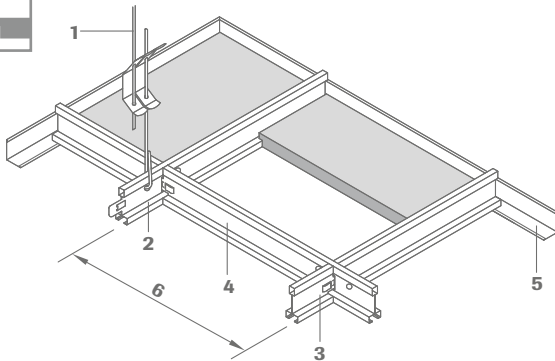

- 1 Hanger no. 12/.../...
- 2 Main tee no. 3500, slots at 600 mm, 610 mm or 625 mm
- 3 Cross tee no. 3512, 600 mm, 610 mm or 625 mm
- 4 Cross tee no. 3514, 1200 mm, 1220 mm or 1250 mm
- 5 Wall angle no. 50G
- 6 Module distance

Section:

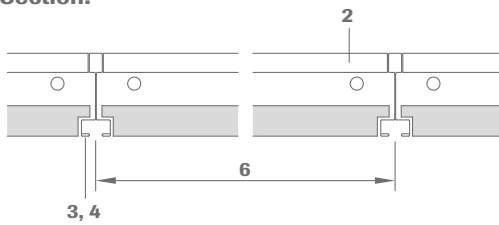

Section dimension:

No. 3500, 3512 and 3514

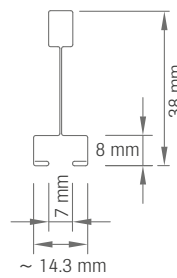

Cross-section:

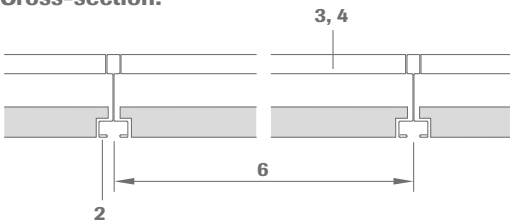

Technical data | mineral tiles

Dimensions

600 x 600 mm, 610 x 610 mm, 625 x 625 mm

Other sizes available on request. Subject to minimum quantities and surcharges. See OWAlifetime collection price list.

Edge details

15b

Thickness

Approx. 15 mm and 20 mm (OWAcoustic® premium)

Reaction to fire

A2-s1,d0 in accordance with EN 13501-1

Resistance to fire

Please see OWA brochure no. 9500 eu/e

Metal suspensions

All metal components listed are galvanized steel or white coated galvanized steel respectively with black or white shadow gap.

Suspension depth

75 - 100 mm (depending on the existing structural ceiling) for ease of panel removal 120 mm is recommended

Wall perimeter:

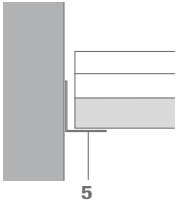

Installation details can be found in OWA-Installation Guide no. 9801 e.

Installation examples:

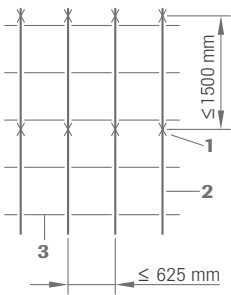

Module 625 x 625 mm

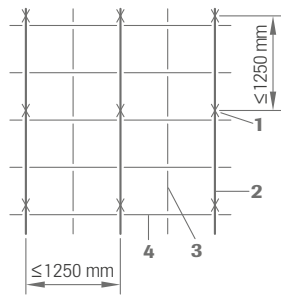

Module 625 x 625 mm

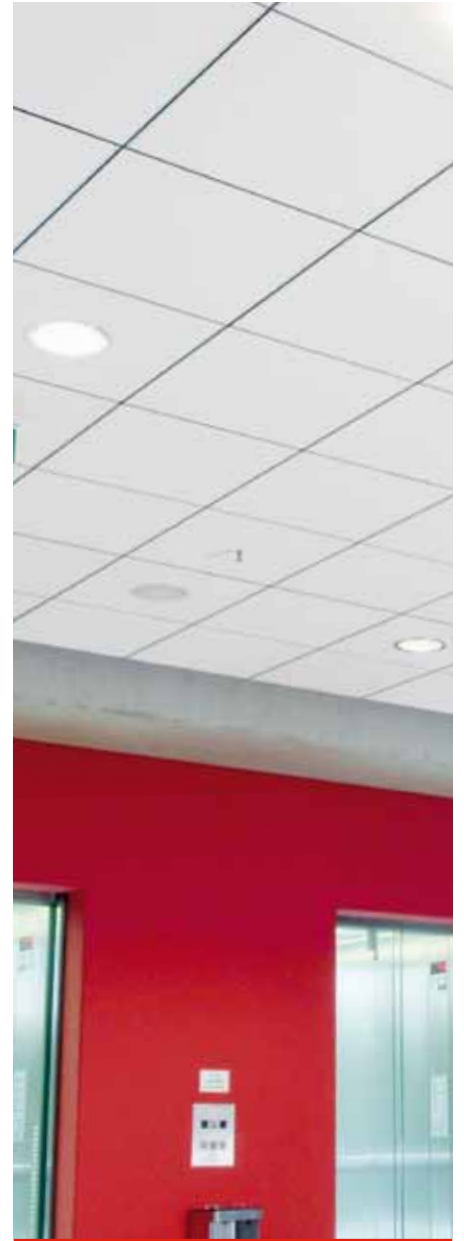

Light fixtures:

Compatible light fixtures please see OWA-brochure no. 9630 e and OWA-Installation Guide no. 9801 e.

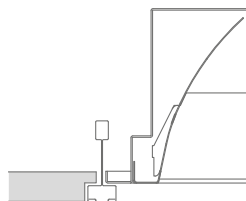

Material requirements per m² (approximations)

Dimensions in mm

No.	Description	600 x 600	610 x 610	625 x 625	625 x 625*
12/.../...	Hanger	0.7 pce	0.7 pce	0.7 pce	1.1 pcs
3500	Main tee, 3600 mm or 3750 mm	0.83 m	0.82 m	0.8 m	1.6 m
3512	Cross tee, 600 mm bzw. 625 mm	0.83 m	0.82 m	0.8 m	1.6 m
3514	Cross tee, 1200 mm bzw. 1250 mm	1.66 m	1.64 m	1.6 m	-
50G	Wall angle	depending on room size and shape			

* Installed with main tee centres (\leq 625 mm)

Weight per m²:

	600 x 600	610 x 610	625 x 625	625 x 625*
Suspension system approx.	1.22 kg/m ²	1.2 kg/m ²	1.18 kg/m ²	1.18 kg/m ²
Tiles 15 mm approx.	4.5 kg/m ²	4.5 kg/m ²	4.5 kg/m ²	4.5 kg/m ²
Tiles 20 mm approx.	6.0 kg/m ²	6.0 kg/m ²	6.0 kg/m ²	6.0 kg/m ²

For special situations, for example addition of wool overlays, light fixtures, cold roofs, high humidity and open areas etc., see OWA-Installation Guide no. 9801 e.

System description:

OWAconstruct® System S 15b – OWAline

Quality statement:

OWAacoustic mineral panels are free from harmful materials such as asbestos and formaldehyde. A statement from the German institute for Building Technology is available. The mineral wool used in these panels is biodegradable. The criteria of the zero-ranking as a carcinogenic material in the chemical prohibition ordinance (§ 1 appendix) section 23 bio-persistent fibres are complied with and therefore carries the "RAL-Seal of mineral wool" guarantees.

Mineral tiles according to EN 13964 and DIN 18177:

Air Permeability	Class PM 1
Formaldehyde	FH Class 1
TVOC	Class 1

Installation should be carried out in accordance with the information contained in system leaflet S 15b OWAline and OWA-Installation Guide no. 9801 e. All components are CE labelled.

Component list:

OWAconstruct hanger no. 12/.../...
OWAconstruct main tee no. 3500
OWAconstruct cross tee no. 3512
OWAconstruct cross tee no. 3514
OWAconstruct wall angle no. 50G



The products meet the requirements as specified of the German environmental classification "low-emission heat insulation materials und suspended ceilings to be used in buildings, RAL UZ 132" (Edition October 2010).

Product Warranties

The information provided in this leaflet is based on the standards and data available at the time of publication. Any performance, warranties or guarantees provided, expressed or implied, are subject to the exclusive use of OWA components and the installation of those components in accordance with our recommendations. Failure to adhere to these conditions will result in the invalidation of any performance claims, warranties or guarantees and rejection of any liability. OWA reserves the right to make any technical improvements to the products, systems or services without prior notice. **All goods and services are supplied in accordance with our current Terms and Conditions of Sale.** Errors excepted!



OWA

Odenwald Faserplattenwerk GmbH

Dr.-F.-A.-Freundt-Straße 3 | 63916 Amorbach
tel +49 93 73.2 01-0 | info@owa.de
www.owa-ceilings.com