



Concealed with shadow gap
edge detail, demountable

OWAlifetime collection

OWA

System S 19 Teccor | concealed with shadow gap edge detail, demountable

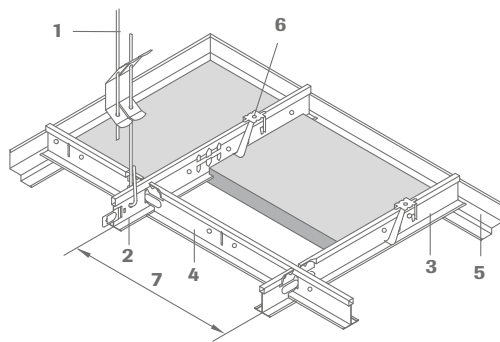

- 1 Hanger no. 12/.../...
- 2 Main tee no. 45, slots at 100 mm or 156.25 mm
- 3 Cross tee no. 46
- 4 Cross tee no. 47
- 5 Shadow wall angle no. 50/19
- 6 Hold down clip no. 819
(to fix the tile in the area of the edge 4c)
- 7 Module distance

Section:

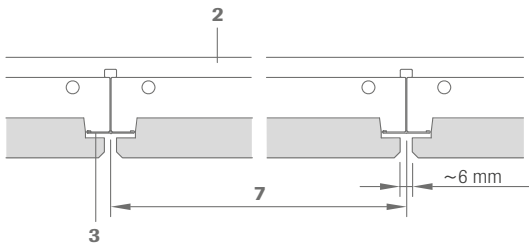

Cross-section:

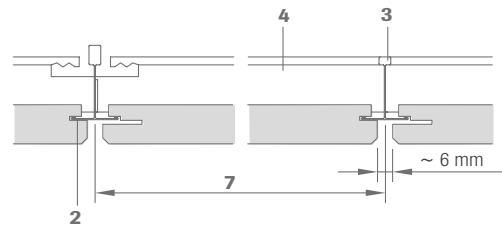

Section dimensions:

No. 45

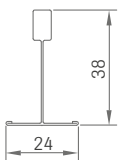

No. 46 and 47

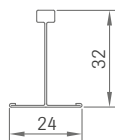

Installation:

The cross tees have connection tabs on each end, 2 cross tee sections are inserted into each slot in the main tee section but care must be taken to insert the tabs correctly so that the tees are in correct alignment. The ends of the main tee sections have offset connectors which will lock when engaged.

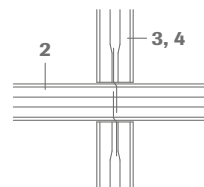

Technical data | mineral tiles

Dimensions

600 x 600 mm, 610 x 610 mm, 625 x 625 mm, 1200 x 600 mm, 1220 x 610 mm, 1250 x 625 mm

Edge details



Thickness

Approx. 20 mm (OWAcoustic® premium)

Moisture resistance



Reaction to fire

A2-s1,d0 in accordance with EN 13501-1

Metal suspensions

All metal components listed are galvanized steel or white coated galvanized steel respectively. For further details and colours please consult OWAlifetime collection price list.

Suspension depth

75 - 100 mm (depending on the existing structural ceiling)

Classes of exposure

Class A according to table 8 EN 13964:2014

Wall perimeter:

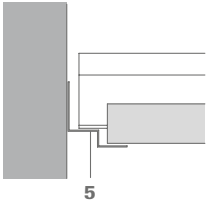

In addition, you can fix the tiles in the area of the wall with some hold down clips no. 819.

Installation details can be found in OWA-Installation Guide no. 9801 e.

Installation examples:

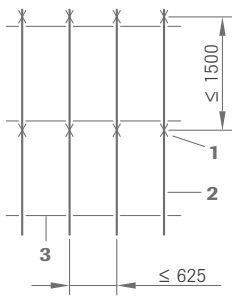

Module 1250 x 625 mm

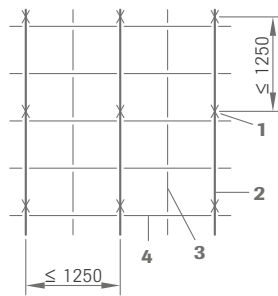

Module 625 x 625 mm

Light fixtures:

Compatible light fixtures please see OWA-brochure no. 9630 e and OWA-Installation Guide no. 9801 e.

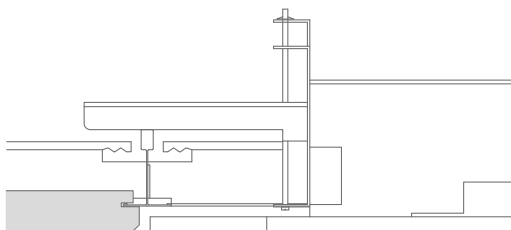

Material requirements per m² (approximations)

Dimensions in mm

No.	Description	600 x 600	610 x 610	625 x 625	1200 x 600	1220 x 610	1250 x 625
12/.../...	Hanger	0.7 pce	0.7 pce	0.7 pce	1.1 pcs	1.1 pcs	1.1 pcs
45	Main tee	0.83 m	0.82 m	0.8 m	1,66 m	1,64 m	1,6 m
46	Cross tee	0.83 m	0.82 m	0.8 m	0,83 m	0,82 m	0,8 m
47	Cross tee	1.66 m	1.64 m	1.6 m	-	-	-
50/19	Shadow wall angle				depending on room size and shape		
819	Hold down clip				depending on room size and shape		

Weight per m²:

	600 x 600	610 x 610	625 x 625	1200 x 600	1220 x 610	1250 x 625
Suspension system approx.	1.25 kg/m ²	1.23 kg/m ²	1.2 kg/m ²	0,94 kg/m ²	0,92 kg/m ²	0,88 kg/m ²
Tiles 20 mm approx.	6.0 kg/m ²	6.0 kg/m ²	6.0 kg/m ²	6,0 kg/m ²	6,0 kg/m ²	6,0 kg/m ²

Further installation details can be found in OWA-Installation Guide no. 9801 e.

System description:

Concealed, demountable OWAconstruct® System S 19 Teccor

Quality statement:

OWAacoustic mineral panels are free from harmful materials such as asbestos and formaldehyde. A statement from the German institute for Building Technology is available. The mineral wool used in these panels is biodegradable. The criterions of the zero-ranking as a carcinogenic material in the chemical prohibition ordinance (§ 1 appendix) section 23 bio-persistent fibres are complied with and therefore carries the "RAL-Seal of mineral wool" guarantees.

Mineral tiles according to EN 13964 and DIN 18177:

Air Permeability Class PM 1
Formaldehyde FH Class 1
TVOC Class 1

Installation should be carried out in accordance with the information contained in system leaflet S 19 Teccor and OWA-Installation Guide no. 9801 e. All components are CE labelled.

Component list:

OWAconstruct hanger no. 12/.../2
OWAconstruct main tee no. 45
OWAconstruct cross tee no. 46, no. 47
OWAconstruct shadow wall angle no. 50/19
OWAconstruct hold down clip no. 819

Product Warranties

The information provided in this leaflet is based on the standards and data available at the time of publication. Any performance, warranties or guarantees provided, expressed or implied, are subject to the exclusive use of OWA components and the installation of those components in accordance with our recommendations. Failure to adhere to these conditions will result in the invalidation of any performance claims, warranties or guarantees and rejection of any liability. OWA reserves the right to make any technical improvements to the products, systems or services without prior notice. **All goods and services are supplied in accordance with our current Terms and Conditions of Sale.** Errors excepted!



Odenwald Faserplattenwerk GmbH

Dr.-F.-A.-Freundt-Straße 3 | 63916 Amorbach | Germany
tel +49 93 73.2 01-0 | info@owa.de
www.owa-ceilings.com