



Exposed grid,  
demountable

OWAlifetime collection

**OWA**

## System S 15 cliq | exposed grid, demountable

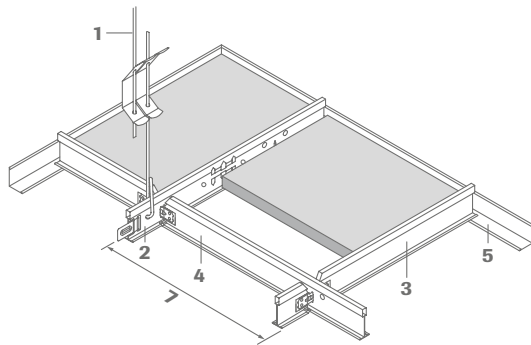

- 1 Hanger no. 12/.../... galv.
- 2 Main tee cliq-15-MR, slots at 100, 152.5 or 156.25 mm centres
- 3 Cross tee cliq-15-CT short
- 4 Cross tee cliq-15-CT long
- 5 Wall angle no. 50G
- 6 Shadow wall angle no. 56
- 7 Module distance

### Section dimensions:

cliq-15-MR,  
cliq-15-CT

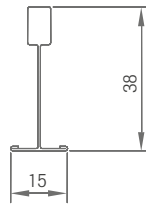

### Section:

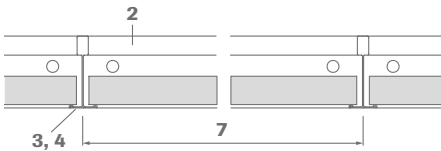

### Cross-section:

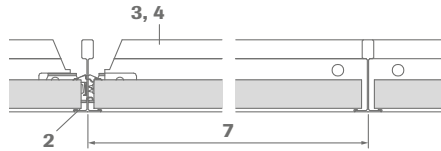

### Construction:

Cross tees are fitted with connection tabs at each end that are inserted into the corresponding vertical slots in the stalk of the main tee. As the tabs are „handed“ care must be taken to ensure each cross tee is inserted into the correct side of the slot (see diagram). Main tees are joined together using the integral locking, offset, end connectors.

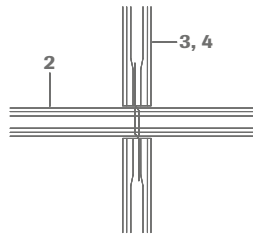

## Technical data | mineral tiles

### Dimensions

600 x 600 mm, 610 x 610 mm, 625 x 625 mm, 1200 x 600 mm, 1220 x 610 mm, 1250 x 625 mm  
widths: 300 mm, 305 mm, 312.5 mm, 400 mm

lengths: 1200 mm, 1220 mm, 1250 mm, 2000\* mm, 2500\* mm

Other sizes available on request. Subject to minimum quantities and surcharges. See OWAlifetime collection price list.

\* Only conditionally demountable

### Edge details

3

### Thickness

Approx. 15 mm and 20 mm (OWAcoustic® premium)  
OWAcoustic® smart on request

### Reaction to fire

A2-s1,d0 in accordance with EN 13501-1

### Resistance to fire

REI 90 (90 minutes) in accordance with EN 13501-2  
test reports are available on request

### Metal suspensions

All profiles are galvanised and visible surfaces painted white. For further details and colours please consult OWAlifetime collection price list.

### Suspension depth

Minimum suspension depth 75 - 100 mm (from underside of soffit). For ease of panel removal 120 mm is recommended.

### Wall perimeter:

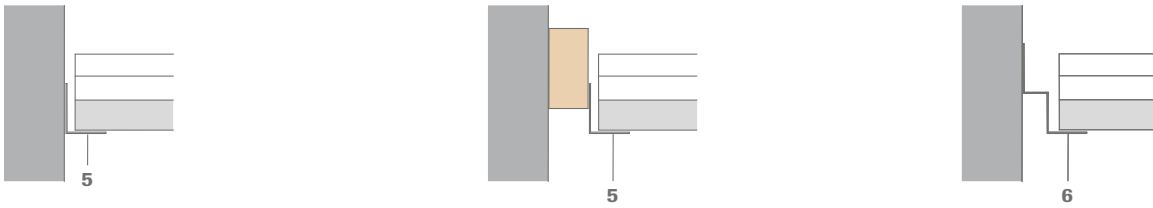

For other examples of wall perimeter and installation see OWA-Installation Guide 801 E.

### Installation examples:

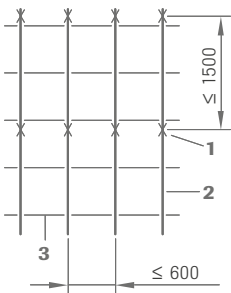

Module 600 x 600 mm

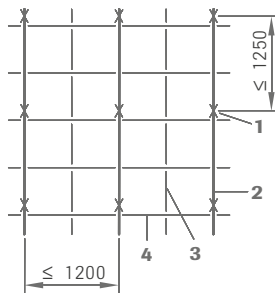

Module 600 x 600 mm

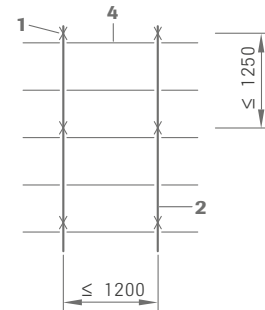

Module 1200 x 600 mm

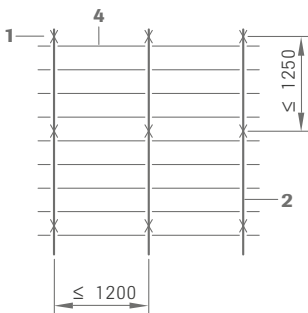

Module 1200 x 300 mm

### Light fixtures:

OWA can supply compatible light fixtures for this system.

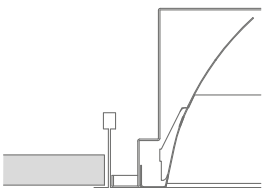

For details of performance, installation and fire resistance please see OWA-brochure no. 9630 e and OWA-Installation Guide no. 801 E.

## Material requirements per m<sup>2</sup> (approximations):

Dimensions in mm

No.	Description	600 x 600	610 x 610	625 x 625	1200 x 600	1220 x 610	1250 x 625	1200 x 300	1250 x 312.5
12/.../...	Hanger	0.7 pce	0.7 pce	0.7 pce	0.7 pce	0.7 pce	0.7 pce	0.7 pce	0.7 pce
cliq-15-MR	Main tee	0.83 lm	0.82 lm	0.8 lm	0.83 lm	0.82 lm	0.8 lm	0.83 lm	0.8 lm
cliq-15-CT	Short cross tee	0.83 lm	0.82 lm	0.8 lm	-	-	-	-	-
cliq-15-CT	Long cross tee	1.66 lm	1.64 lm	1.6 lm	1.66 lm	1.64 lm	1.6 lm	3.33 lm	3.2 lm
50G	Wall angle	dependent on room size and shape							

## Weight per m<sup>2</sup>:

	600 x 600	610 x 610	625 x 625*	1200 x 600	1220 x 610	1250 x 625	1200 x 300	1250 x 312,5
Suspension system approx.	1.06 kg/m <sup>2</sup>	1.05 kg/m <sup>2</sup>	1.06 kg/m <sup>2</sup>	0.81 kg/m <sup>2</sup>	0.83 kg/m <sup>2</sup>	0.78 kg/m <sup>2</sup>	1.32 kg/m <sup>2</sup>	1.27 kg/m <sup>2</sup>
Tiles 15 mm approx.	4.5 kg/m <sup>2</sup>	4.5 kg/m <sup>2</sup>	4.5 kg/m <sup>2</sup>	4.5 kg/m <sup>2</sup>	4.5 kg/m <sup>2</sup>	4.5 kg/m <sup>2</sup>	4.5 kg/m <sup>2</sup>	4.5 kg/m <sup>2</sup>

For special situations, for example addition of wool overlays, light fittings, cold roofs, high humidity and open areas etc., see OWA-Installation Guide no. 801. For fire resistant ceilings, the distances between main tee profiles and suspension points must comply with the relevant test reports (see brochure no. 9500 EU).

## System description:

### Exposed grid OWAacoustic® System S 15 (Lay-in system)

#### Quality Statement:

OWAacoustic mineral panels are free from harmful materials such as asbestos and formaldehyde. A statement from the German institute for Building Technology is available. The mineral wool used in these panels is biodegradable. The criteria of the zero-ranking as a carcinogenic material in the chemical prohibition ordinance (§ 1 appendix) section 23 bio-persistent fibres are complied with and therefore carries the "RAL-Seal of mineral wool" guarantees.

Mineral tiles according to EN 13964 and DIN 18177:

Air Permeability Class PM 1  
Formaldehyde FH Class 1  
TVOC Class 1

**Installation** should be carried out in accordance with the information contained in system leaflet S 15 cliq and OWA-Installation Guide no. 801 E. All components are CE labelled.

#### Component list:

OWAconstruct hanger no. 12/.../2  
OWAconstruct main tee cliq-15-MR  
OWAconstruct cross tees cliq-15-CT long and short  
OWAconstruct wall angle no. 50G

## Product Warranties

The information provided in this leaflet is based on the standards and data available at the time of publication. Any performance, warranties or guarantees provided, expressed or implied, are subject to the exclusive use of OWA components and the installation of those components in accordance with our recommendations. Failure to adhere to these conditions will result in the invalidation of any performance claims, warranties or guarantees and rejection of any liability. OWA reserves the right to make any technical improvements to the products, systems or services without prior notice. **All goods and services are supplied in accordance with our current Terms and Conditions of Sale.** Errors excepted!



# OWA

## Odenwald Faserplattenwerk GmbH

Dr.-F.-A.-Freundt-Straße 3 | 63916 Amorbach  
tel +49 93 73.2 01-0 | info@owa.de  
www.owa-ceilings.com